

Consultar en: www.uah.es/otrosweb/quimica_organica/Docencia/lic de Farmacia/Heterociclos de Uso Farmacéutico
o en **Mi Portal**

CAP 01. HETEROCICLOS DE USO FARMACEUTICO

CLASIFICACION
NOMENCLATURA
ESTRUCTURA
REACTIVIDAD
SINTESIS

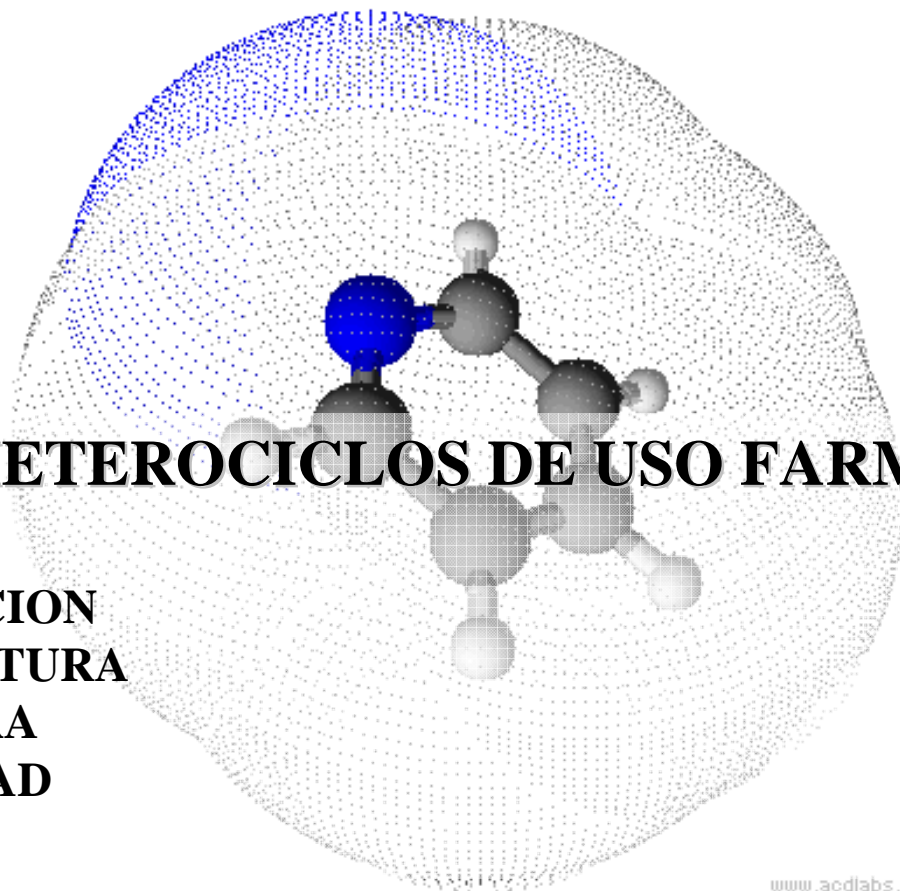

www.acdlabs.com

¿POR QUE ESTUDIAMOS HETEROCICLOS DE USO FARMACEUTICO?

NCE y NBE 1994-2009. PRODUCTOS HETEROCICLICOS

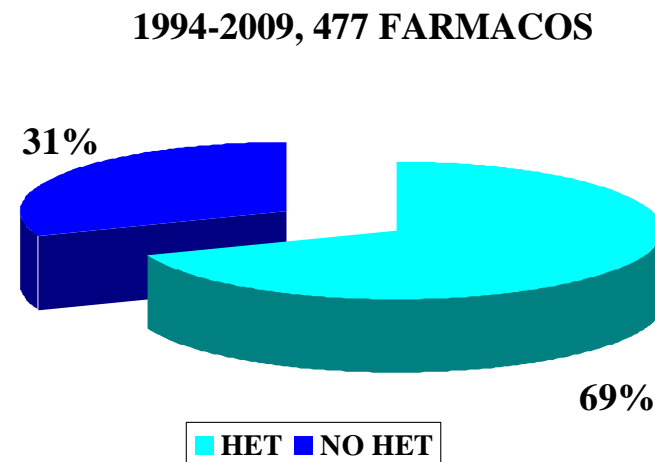
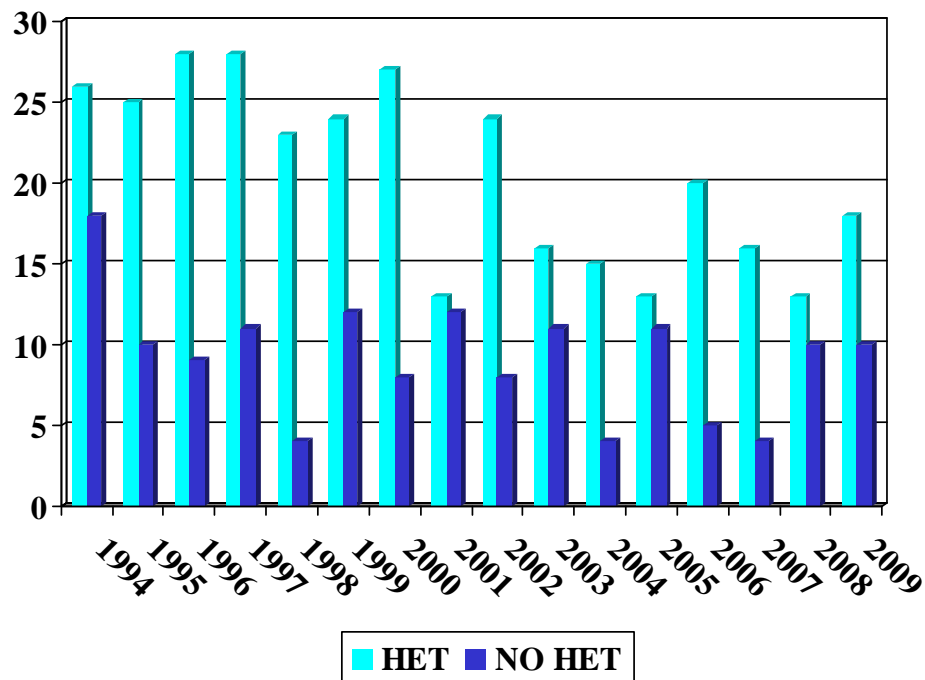

Heterociclos aromáticos

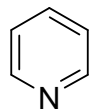

Piridina

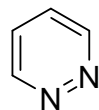

Piridazina

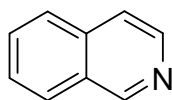

Isoquinolina

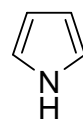

Pirrol

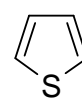

Tiofeno

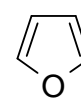

Furano

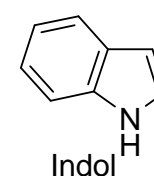

Indol

Heterociclos no aromáticos

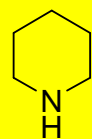

Piperidina

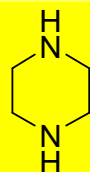

Piperazina

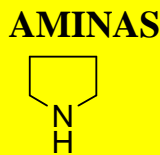

Pirrolidina

AMINAS

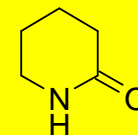

Piperidin-2-ona

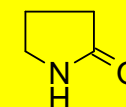

Pirrolidin-2-ona

AMIDAS

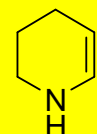

Tetrahidropiridina

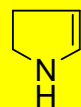

Pirrolina

ENAMINAS

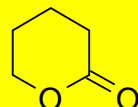

Tetrahidropiran-2-ona

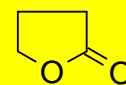

Dihidrofuran-2-ona

ESTERES

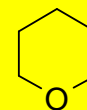

Tetrahidropirano



Tetrahidrofurano

ETERES

HETEROCICLOS AROMATICOS. NOMBRES VULGARES

6 miembros y benzoanálogos

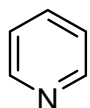

Piridina

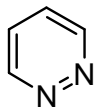

Piridazina

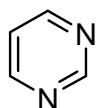

Pirimidina

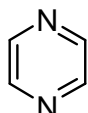

Pirazina

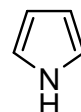

Pirrol



Tiofeno



Furano

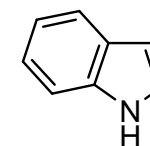

Indol

5 miembros y benzoanálogos

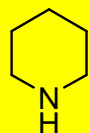

Piperidina

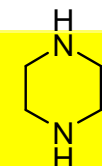

Piperazina

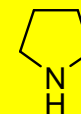

Pirrolidina



Tetrahidro
furano

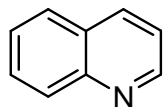

Quinolina
o Quinoleina

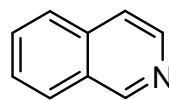

Isoquinolina
o Isoquinoleina

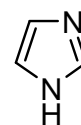

Imidazol



Tiazol



Oxazol

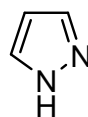

Pirazol



Isotiazol



Isoxazol

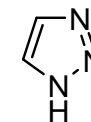

1,2,3-triazol

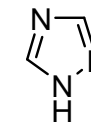

1,2,4-triazol

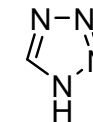

Tetrazol
5

CARBOCICLOS AROMATICOS, ESTRUCTURA Y FORMAS RESONANTES

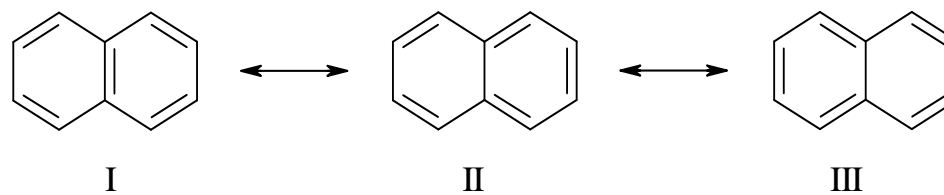
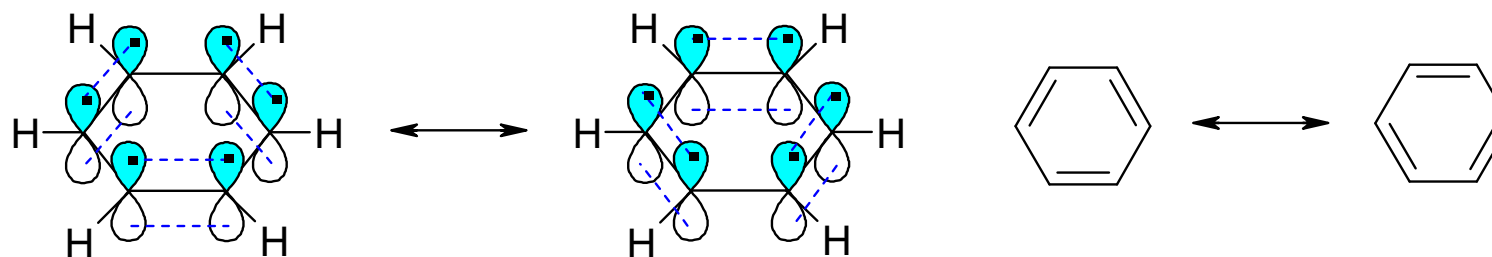

CARBOCICLOS AROMATICOS, ESTRUCTURA Y FORMAS RESONANTES

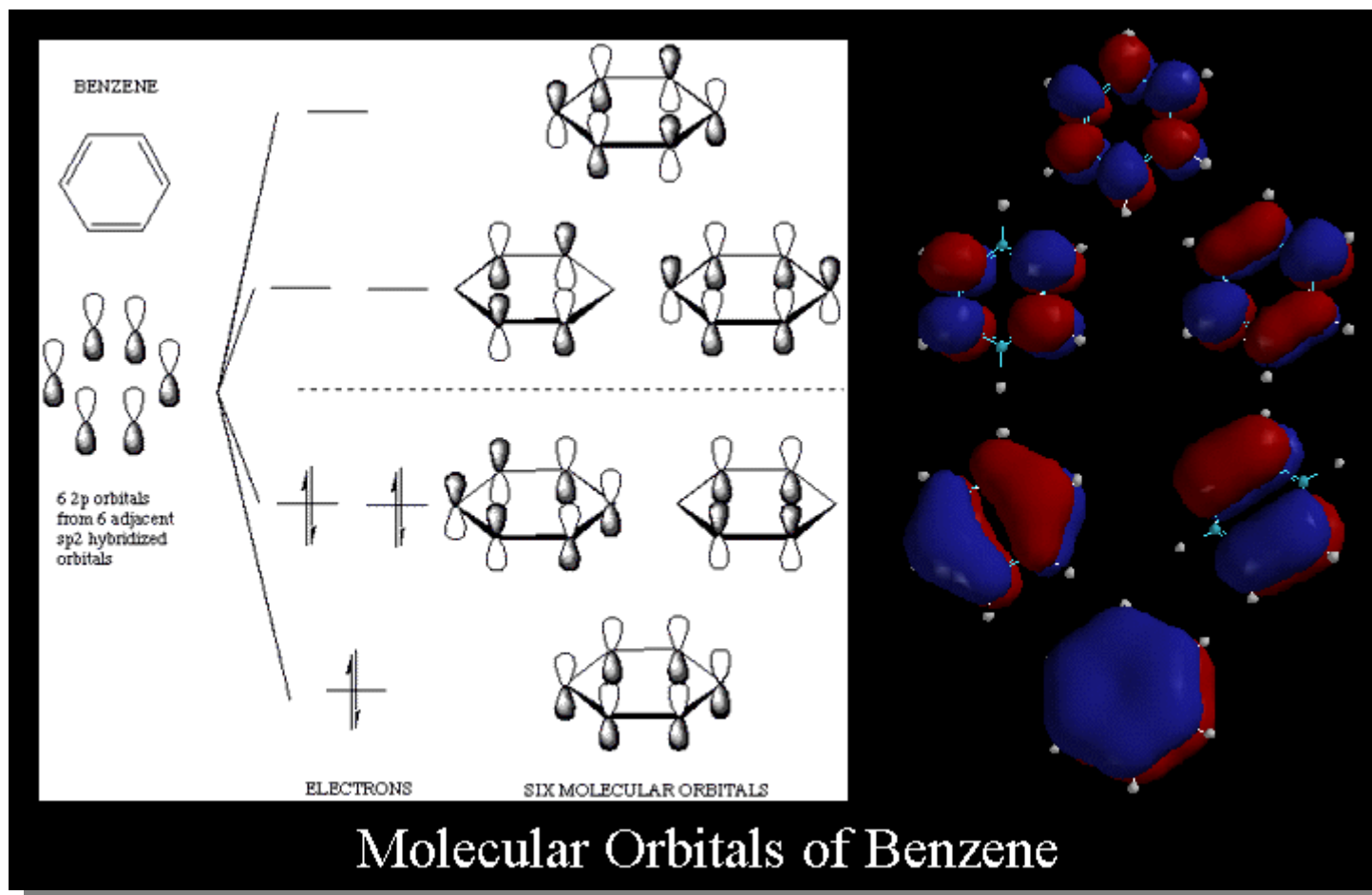

CARBOCICLOS AROMATICOS, ESTRUCTURA Y FORMAS RESONANTES ORBITALES MOLECULARES ENLAZANTES

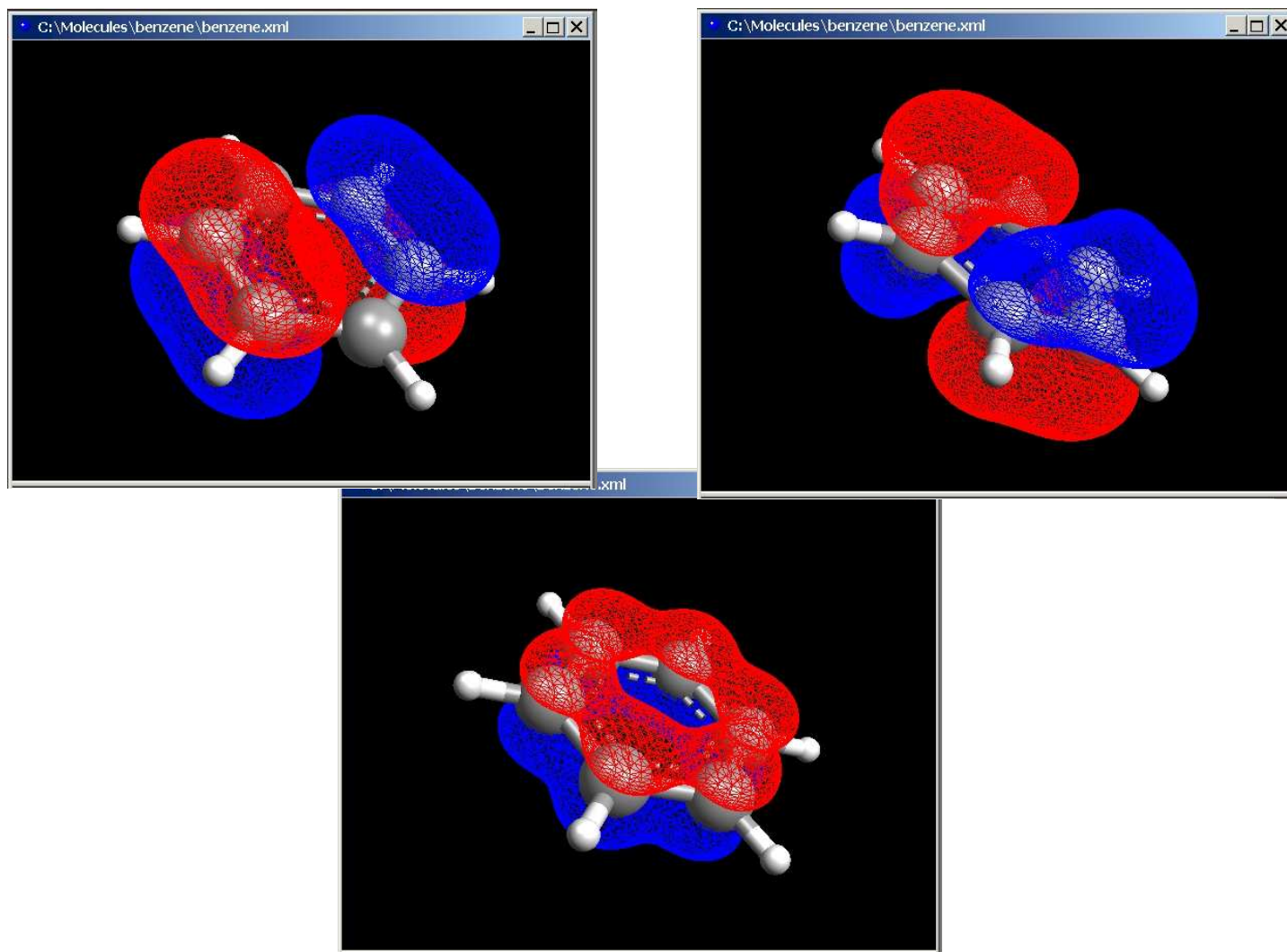

PIRIDINA, ESTRUCTURA Y FORMAS RESONANTES

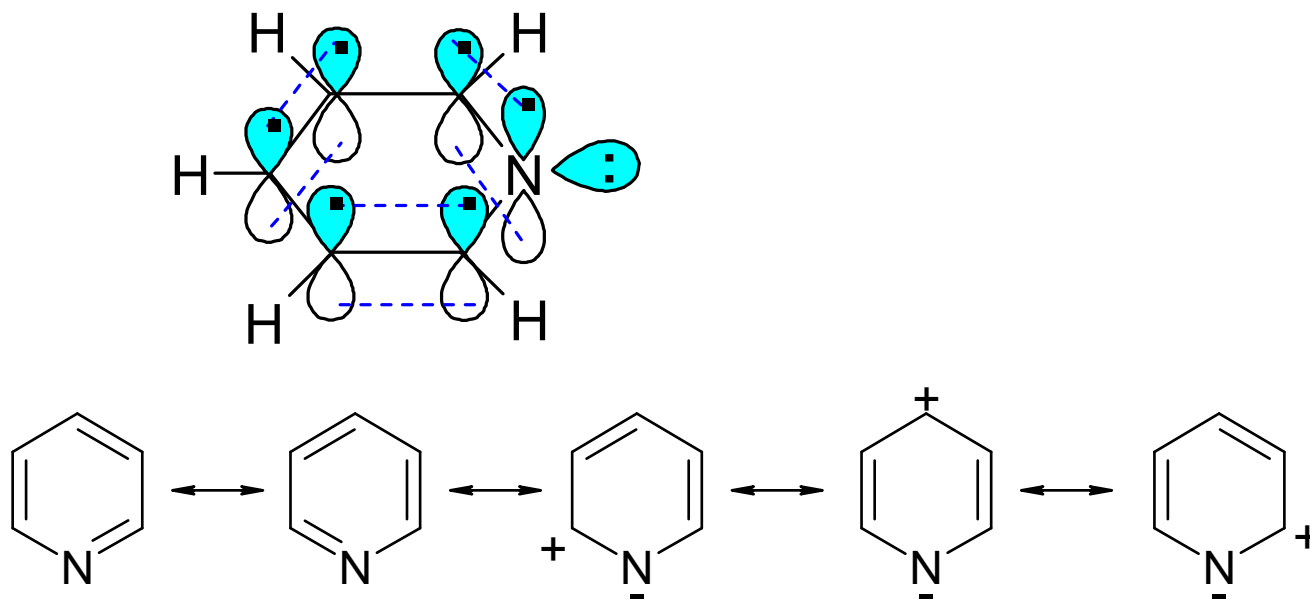
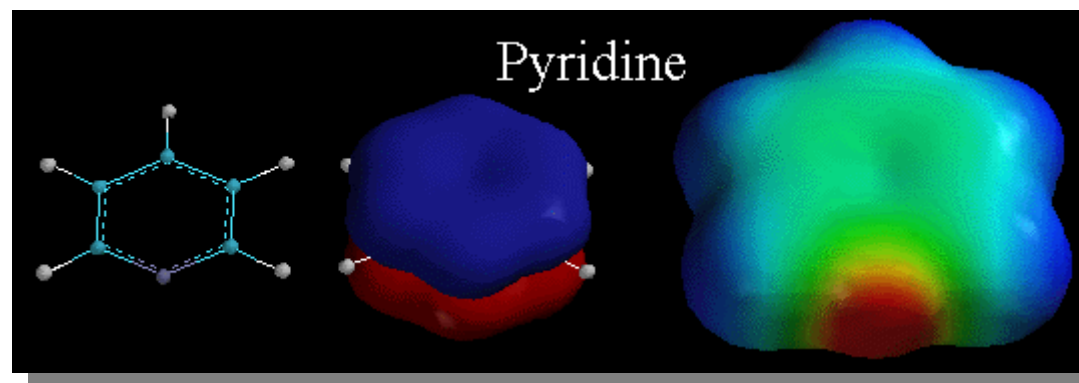

PIRIMIDINA, ESTRUCTURA Y FORMAS RESONANTES

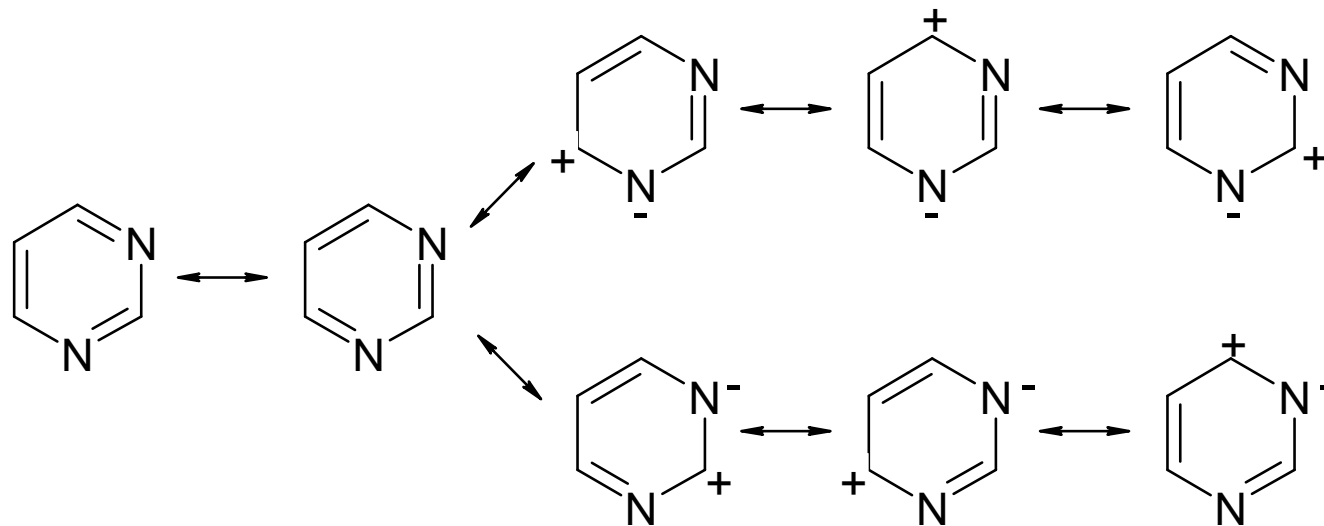
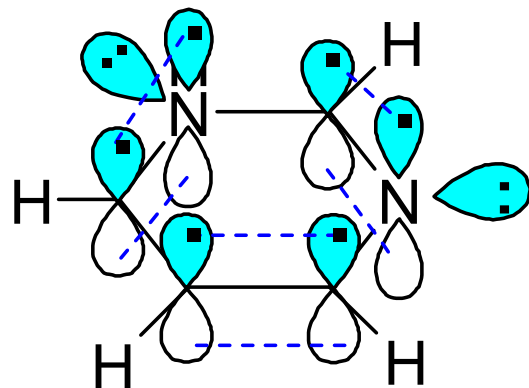

PIRIDAZINA Y PIRAZINA, ESTRUCTURA Y FORMAS RESONANTES

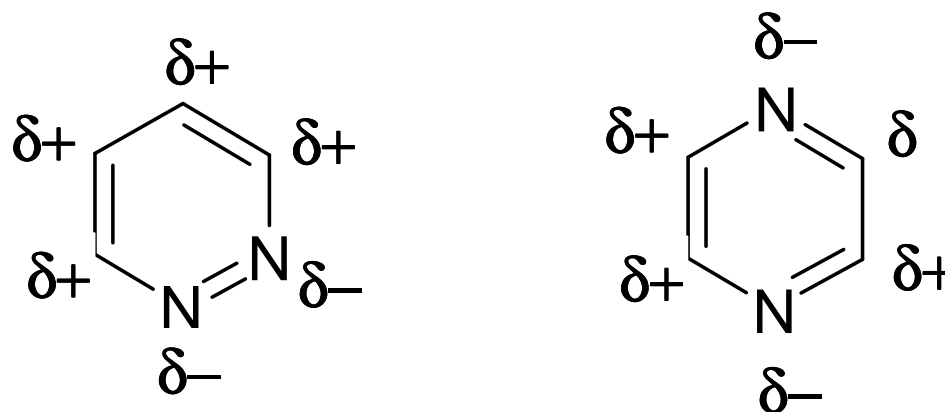

Revisar formas canónicas

SALES DE PIRIDINIO, ESTRUCTURA Y FORMAS RESONANTES

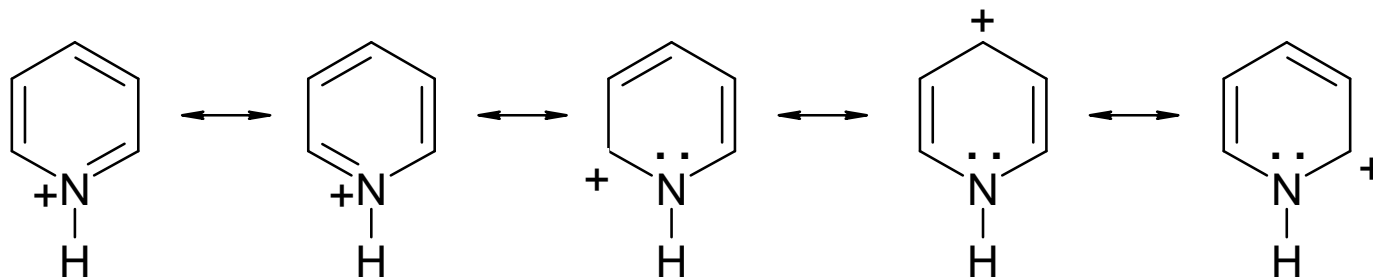
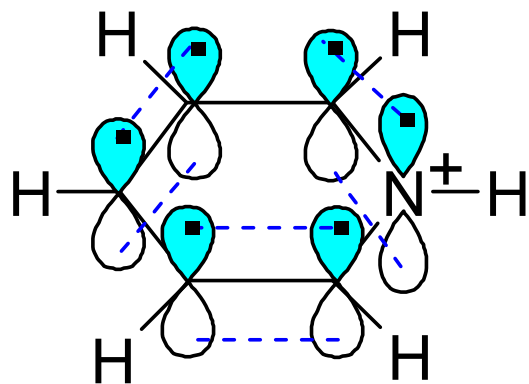

SALES DE PIRILIO, ESTRUCTURA Y FORMAS RESONANTES

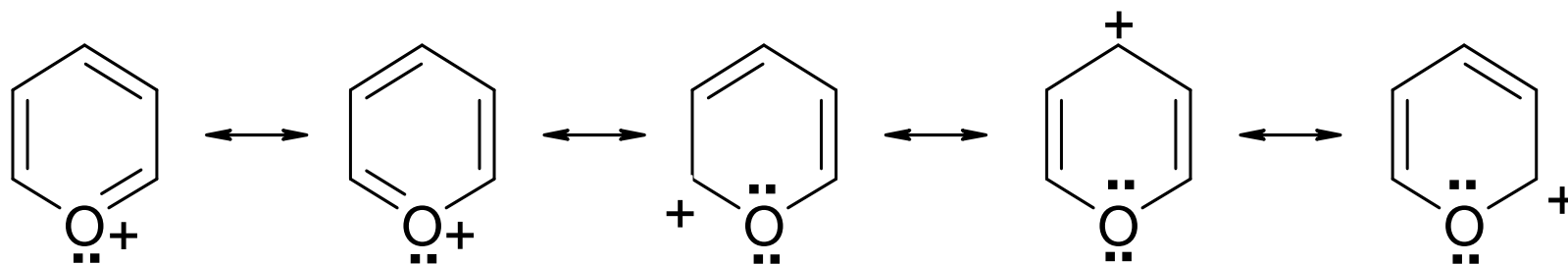
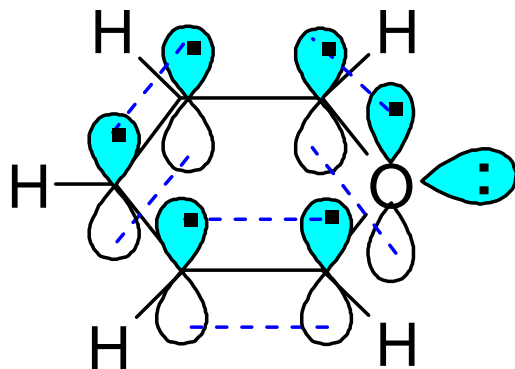

HIDROXIPYRIDINAS Y PIRONAS, ESTRUCTURA Y FORMAS RESONANTES

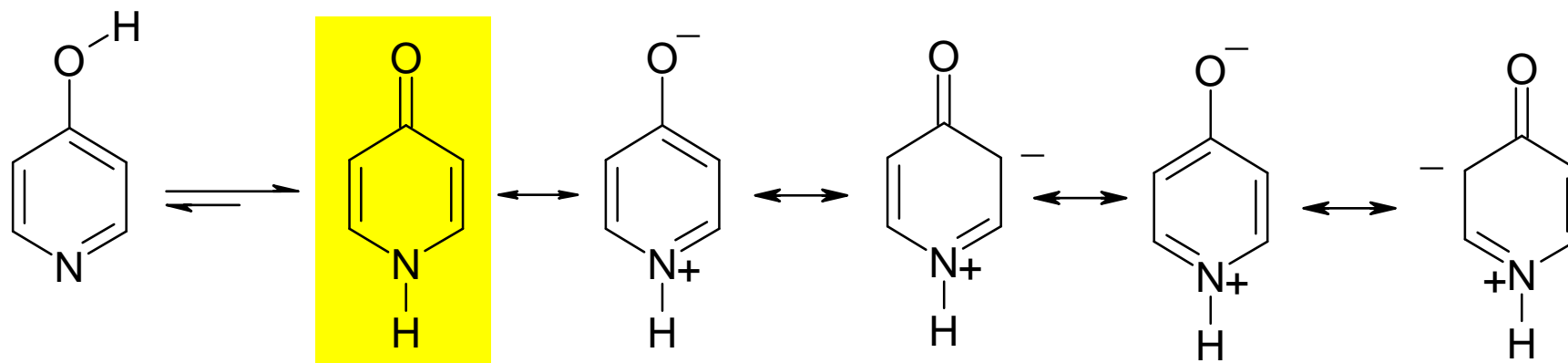

4-Hidroxipiridina

4-Piridona

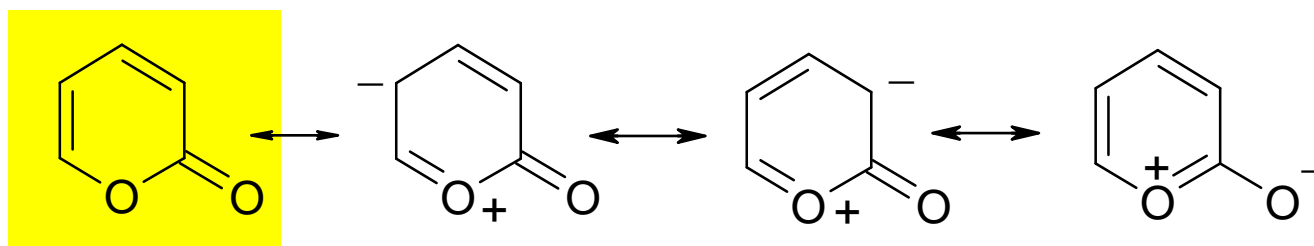

2-Pirona

ANION CICLOPENTADIENILO, ESTRUCTURA Y FORMAS RESONANTES

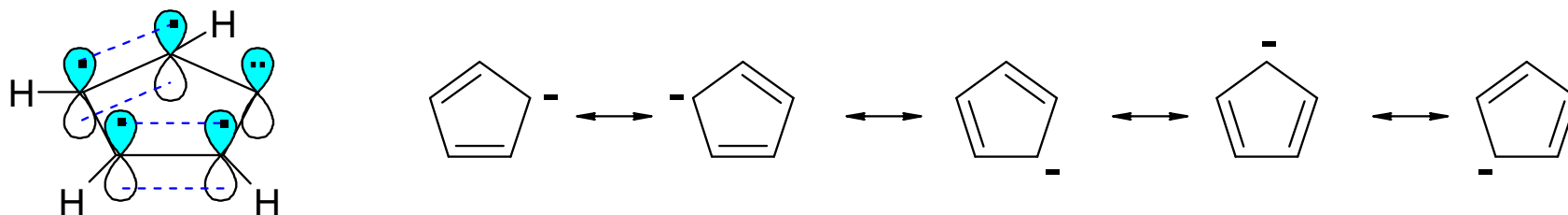

PIRROL, ESTRUCTURA Y FORMAS RESONANTES

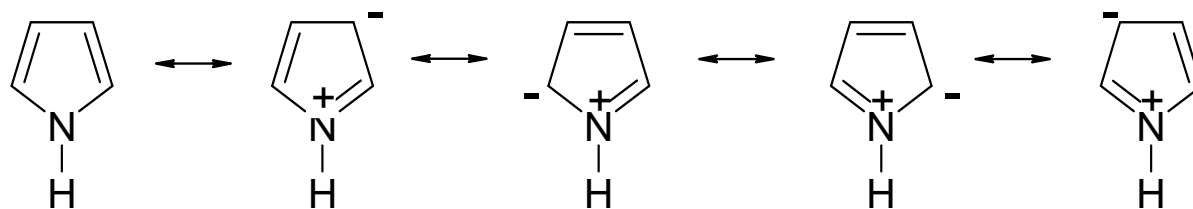
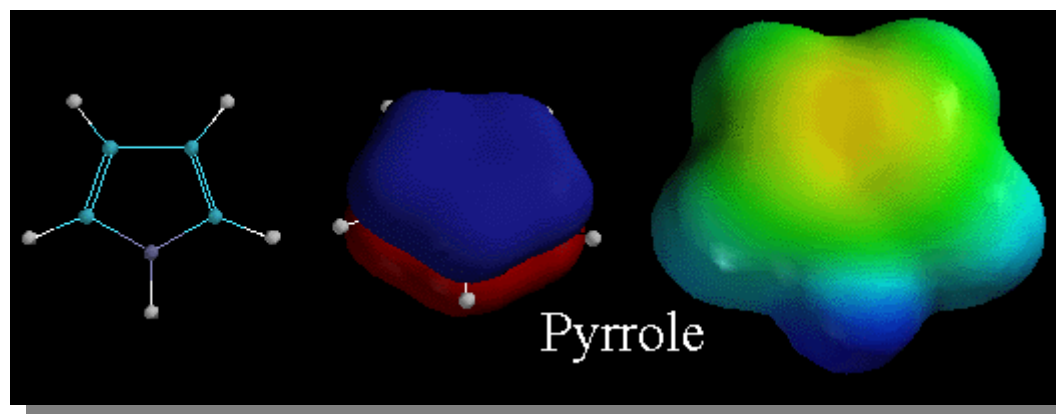
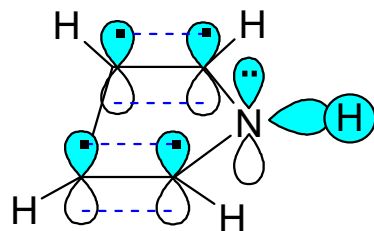

FURANO Y TIOFENO, ESTRUCTURA Y FORMAS RESONANTES

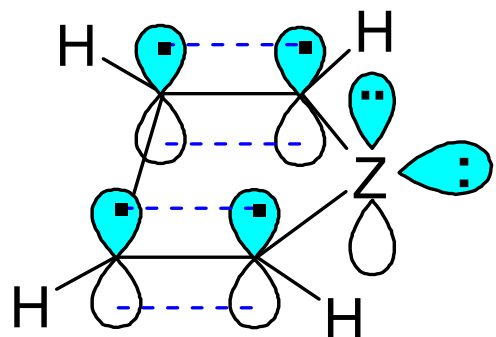

Z=O Furano
Z=S Tiofeno

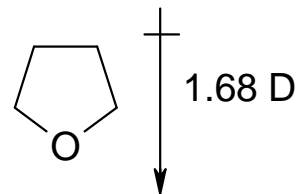
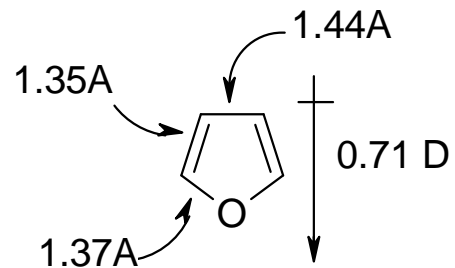
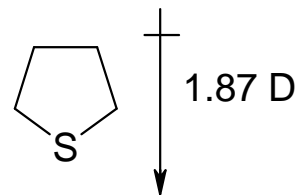
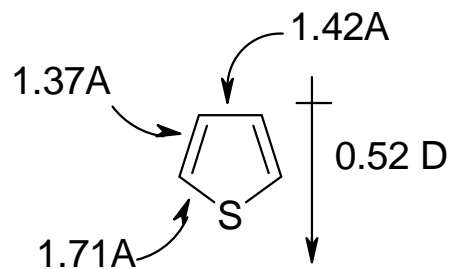

1,3-AZOLES, ESTRUCTURA Y FORMAS RESONANTES

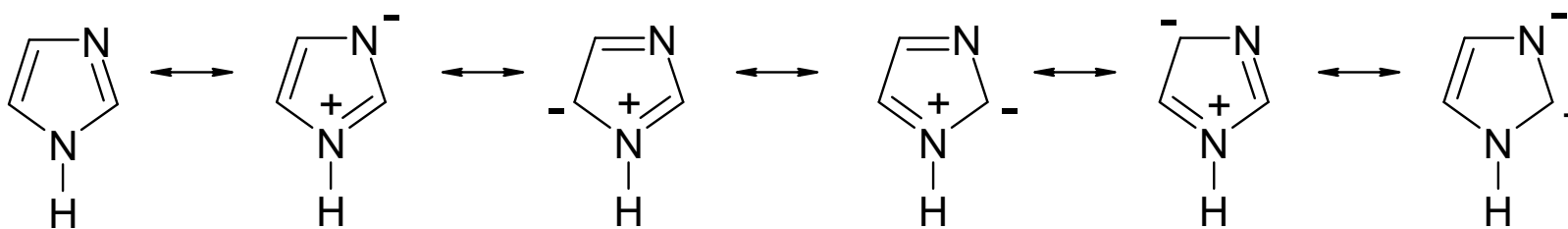
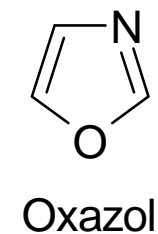
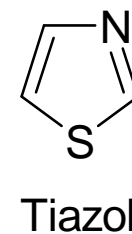
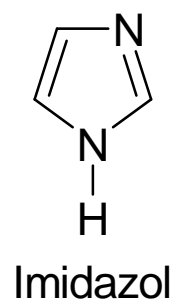
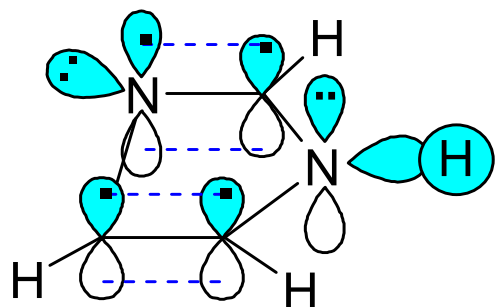

1,2-AZOLES, ESTRUCTURA Y FORMAS RESONANTES

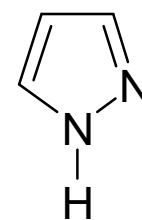
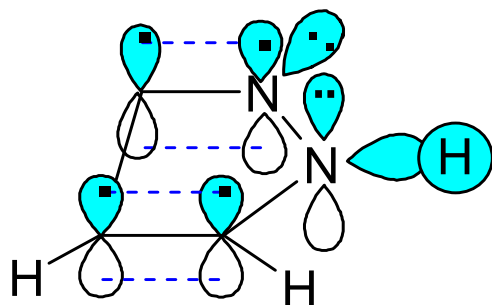

Pirazol

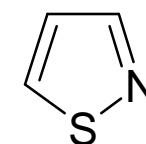

Isotiazol

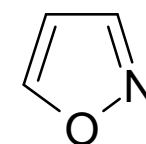

Isoxazol

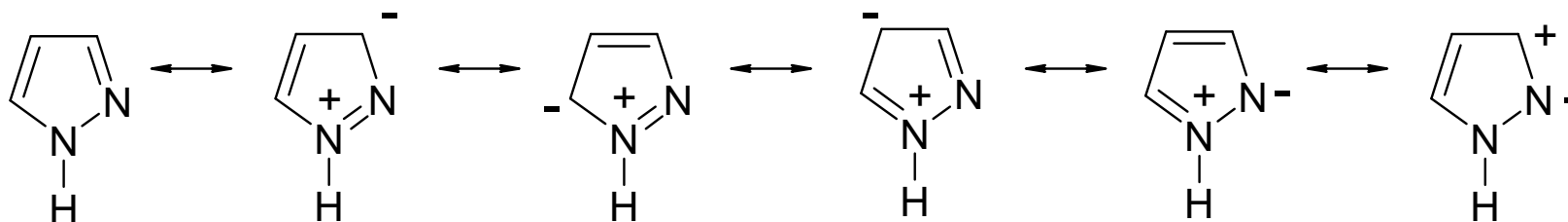

TRIAZOLES Y TETRAZOLES, ESTRUCTURA Y FORMAS TAUTOMERICAS

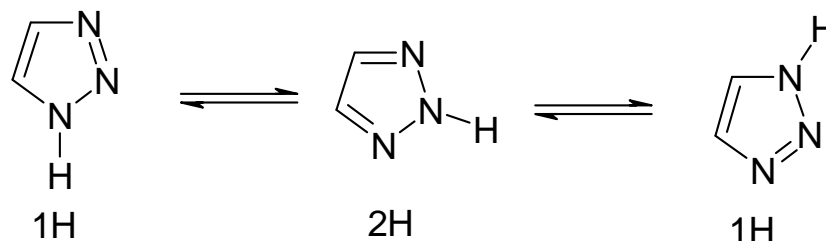
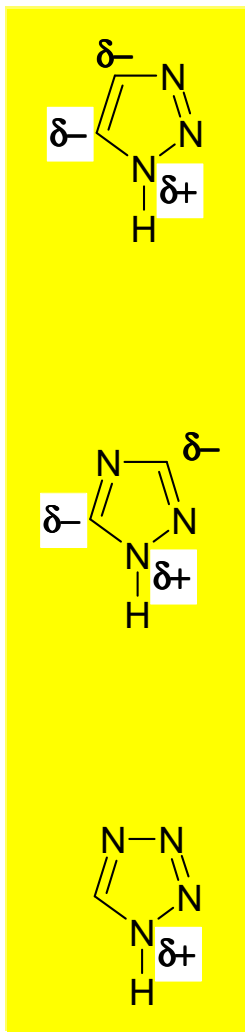

1,2,3-triazol

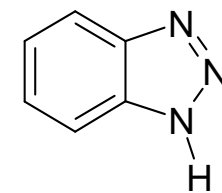

benzotriazol

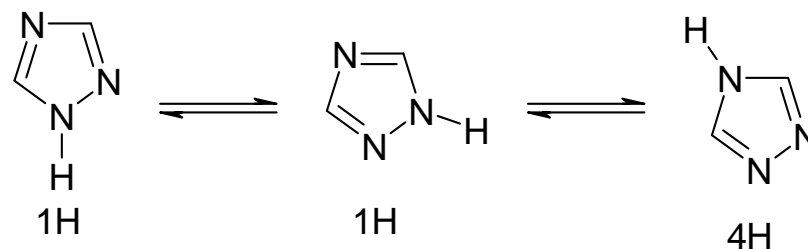

1,2,4-triazol

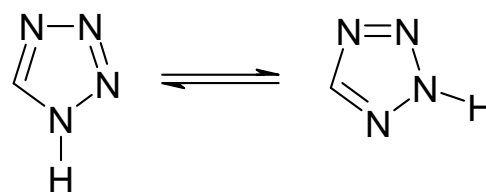

tetrazol

BENZOHETEROCICLOS, ESTRUCTURA Y FORMAS RESONANTES

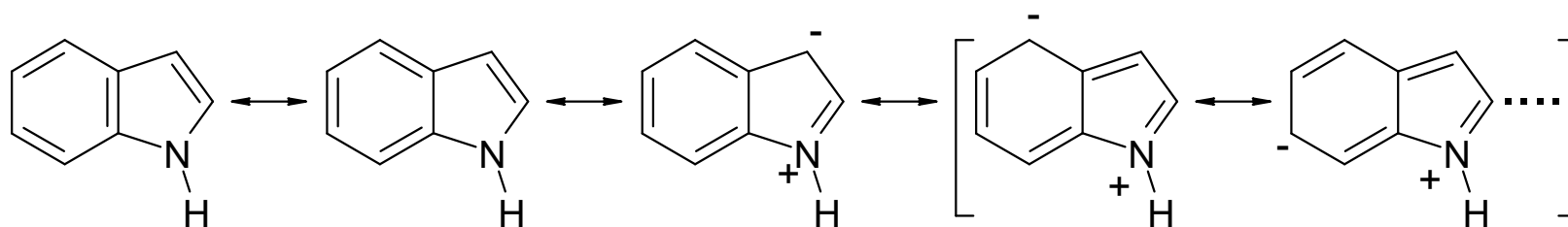
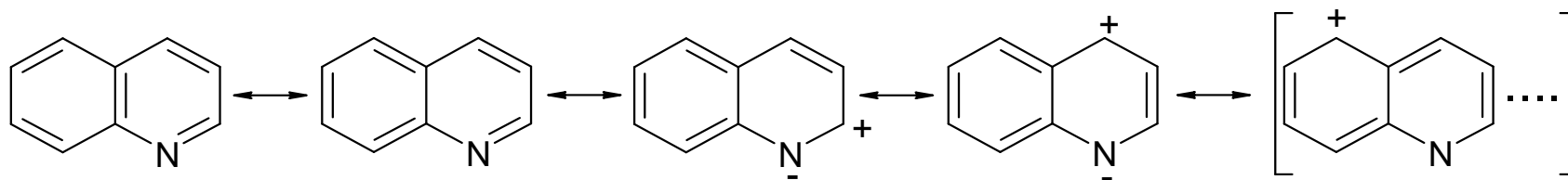
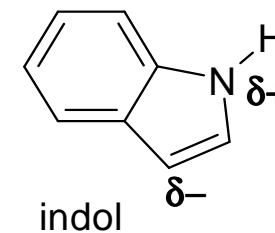
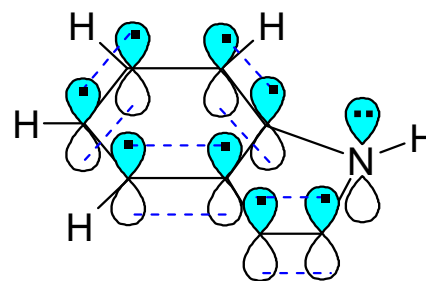
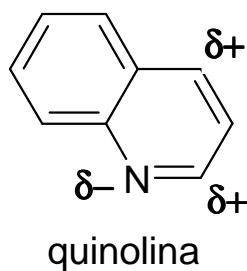
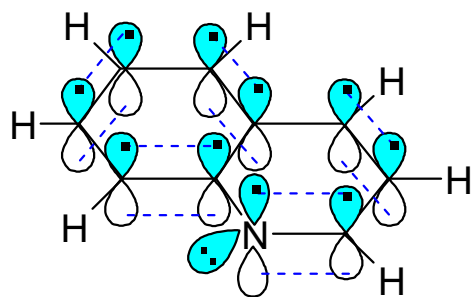

TAUTOMERIA DE DERIVADOS DE PIRIDINA

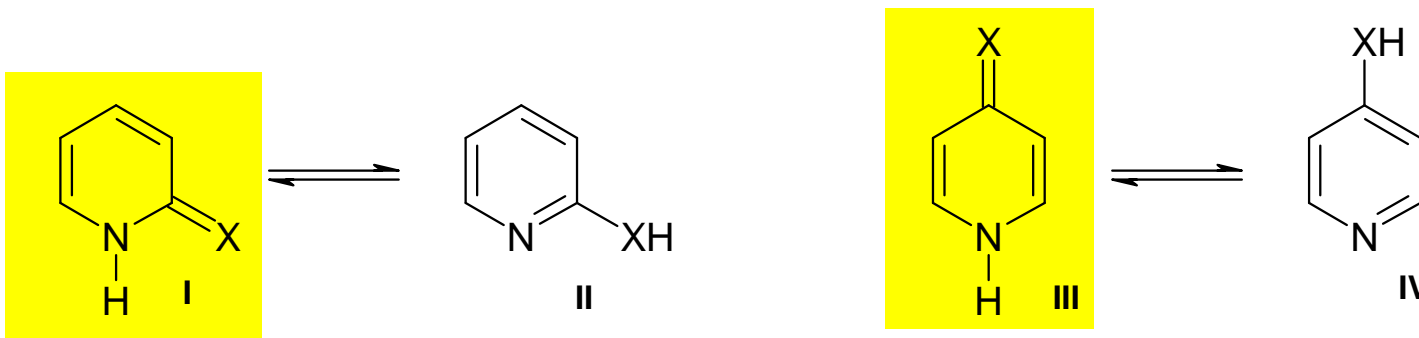

X=O, predominan I y III; X=N, predominan II y IV

$\lambda_{\max}(\text{EtOH})$	$\lambda_{\max}(\text{EtOH})$	$\lambda_{\max}(\text{EtOH})$
229 (3.85)	230 (3.78)	270 (3.55)
300 (3.70)	305 (3.70)	

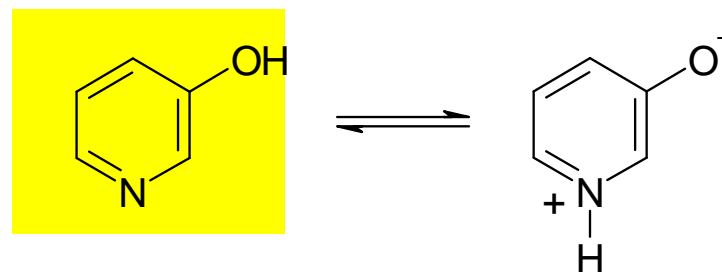

TAUTOMERIA EN AZOLES

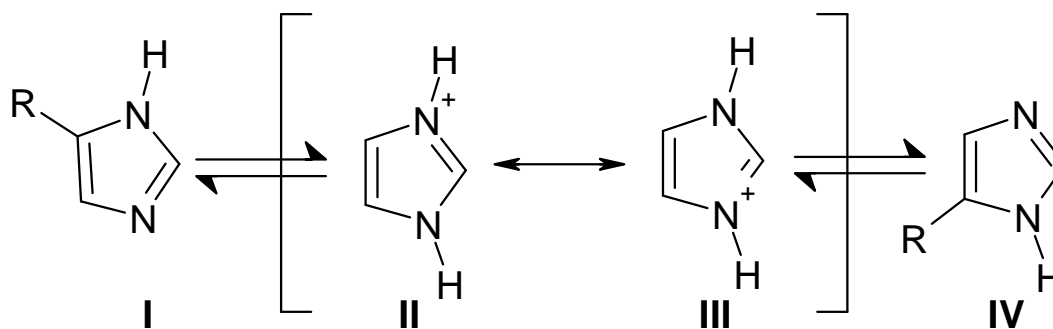

No es posible distinguir un N de otro. Similar en pirazol

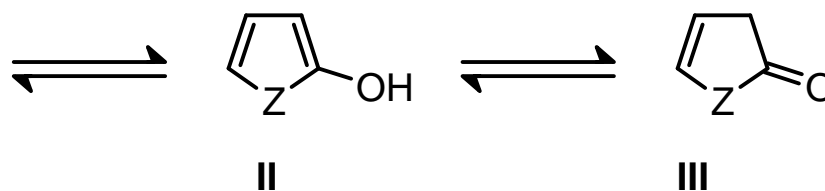
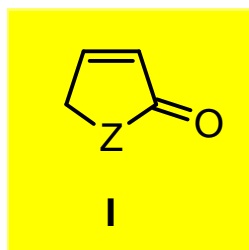

Z=O, S, NR predomina I

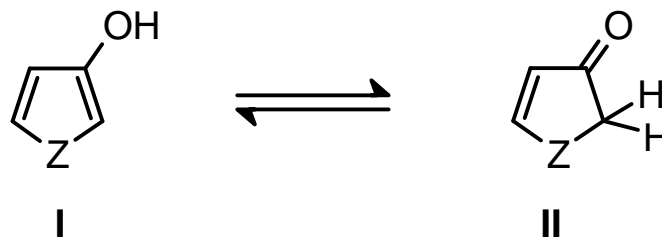

Z=S predomina I
Z=O, NR predomina II